

DIALITE X LED

Rise & Fall Pendant

2 x 24 Watt



Made in Germany

Information

X 2/24 LED

Suspended LED light at rise & fall pendants.
Powerful high contrast light, cool and flicker free.

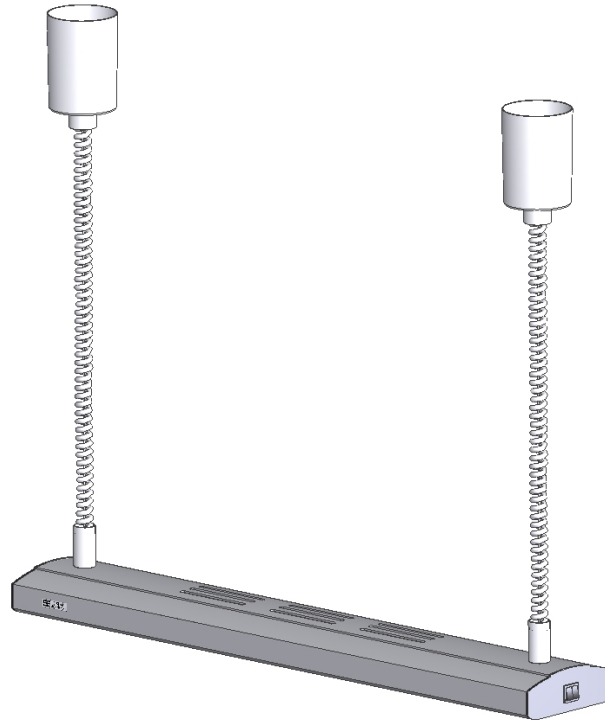

Two LED Lamps

2 x 24 Watt exchangeable LED lamps mounted in parallel order

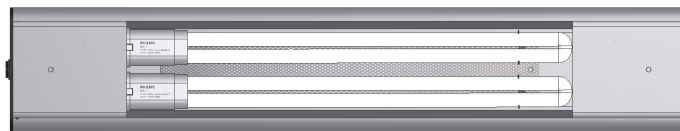

Spectro LED TP

Two LED lines per lamp, capsuled in safety-hard glass tubes.



Highest Contrast

The matted cover of the LED lamps with special semi transparent glass provides diffuse as well as very contrasty LED light.

LED Power/
Luminous flux

6,800 lumen

Energy Saving

The low connection power of the LED lamps alone can only be limited counted as energy saving in comparison to compact fluorescent lamps. The striking point is the luminous flux (lumen) that creates the respective illumination. Depending on the light type the LED energy saving can be calculated with 20-30%, with same illuminance of course.

DIALITE X LED

Rise & Fall Pendant

2 x 24 Watt



Made in Germany

Information

Diffuse and contrasty LED light

The matted hard glass tubes of the LED lamps are consisting of semi transparent glass. This unique making provides an even light distribution and same time high contrast!

Like this the light power is used to almost 100% capacity. No matt perspex diffusers are needed that are considerably reducing illuminance and contrast. Also, the energy efficiency is no more coherent.

SpectroLED TP Lamp Service

The LED lamps are socketed and thus exchangeable! As well as with fluorescent lamps the LED can be exchanged easily for a different colour of light or for service without expenditure on repair.

Thus, these unique lights do not only have an economic but also an ecologic aspect. Only the LED lamp has to be disposed, not the whole luminaire itself.

Lamps Colours of Light Mixed Light

Essential for the vision task is the colour of light of the LED.

At choice are daylight 6,500 Kelvin / 5,800K, neutral white 4,000K and incandescent yellow 3,000K. All DIALITE reflectors have two parallel lamp positions. If two lamps of different colours of light are used the task can be illuminated in alternate or mixed colours. Thus it is possible to work with three different colours of light.

Two Switches

Both lamps are separately switchable for full or half lighting power.

electronic

Flimmer- and flickerfree operation by a converter for each LED lamp.

Illuminance

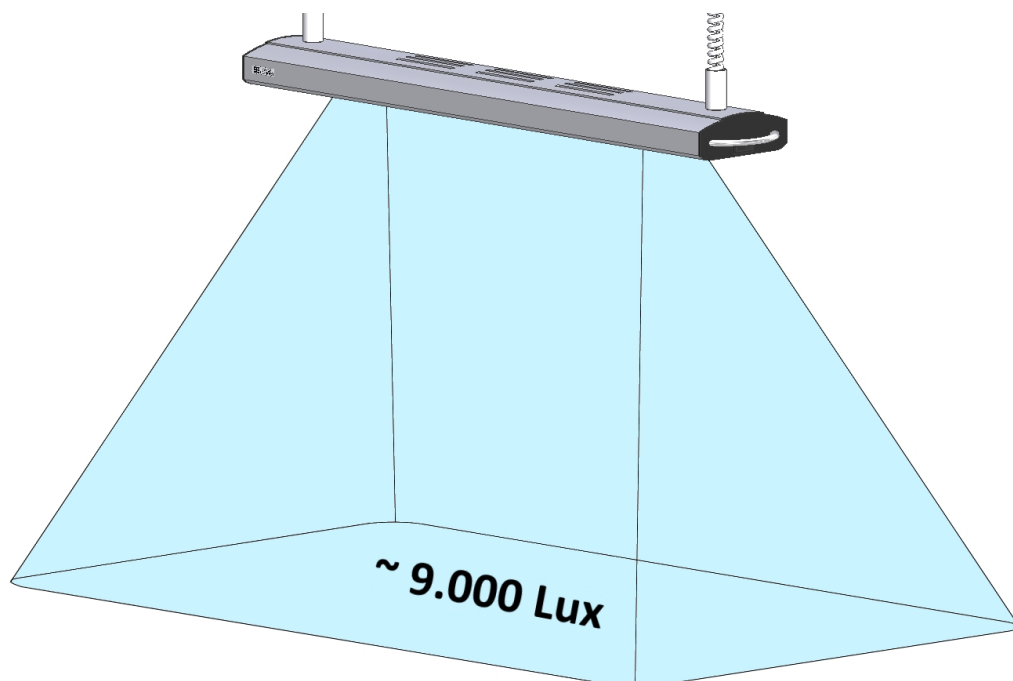

DIALITE X LED

Rise & Fall Pendant

2 x 24 Watt



Made in Germany

Cool Reflector

The slits at the topside of the reflector are unique for LED lights. The **heat** of the LED is exhausted and thus provides a **cool** reflector. Good for comfortable temperatures in the area of the head.

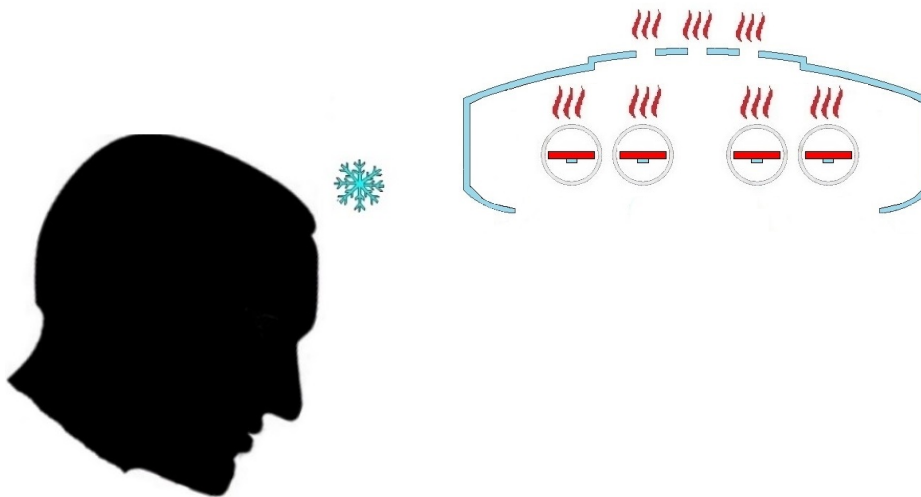

Thermo-Protect TP

Due to the slits in the reflector top side both, reflector and LED lamps are even short-term flame resistant as its **heat** exhausts through the top side slits – without damage.

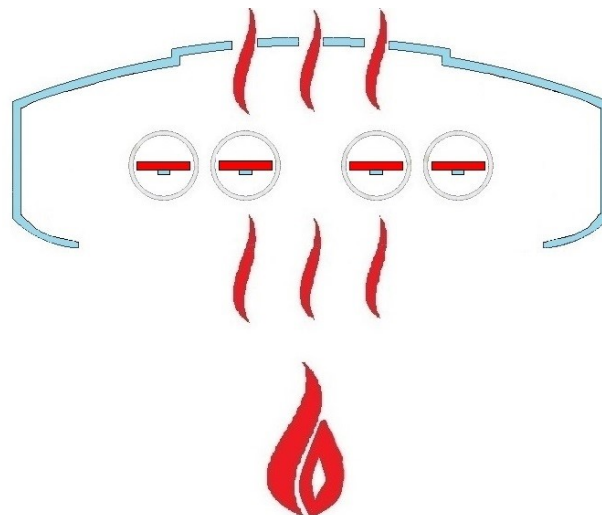

Metal Side parts

The plastic side parts of the reflector are optional available in metal make. Like this the reflector is even more resistant against flames.

Reflector/Dimensions

Solid aluminium profile with resistant silver-grey epoxy coating.
White inner reflector for authentic colour rendering.
Elegant handles for easy handling

DIALITE X LED

Rise & Fall Pendant

2 x 24 Watt



Made in Germany

Information

Rise & Fall Pendants

Heavy duty precision quality for individual stepless level adjustment to the task. The rise and fall pendants are white. Extension good for ceilings up to 3,40m (11 ft). If the room ceiling is higher, rise & fall pendants with a longer extension are necessary or ropes have to be used.

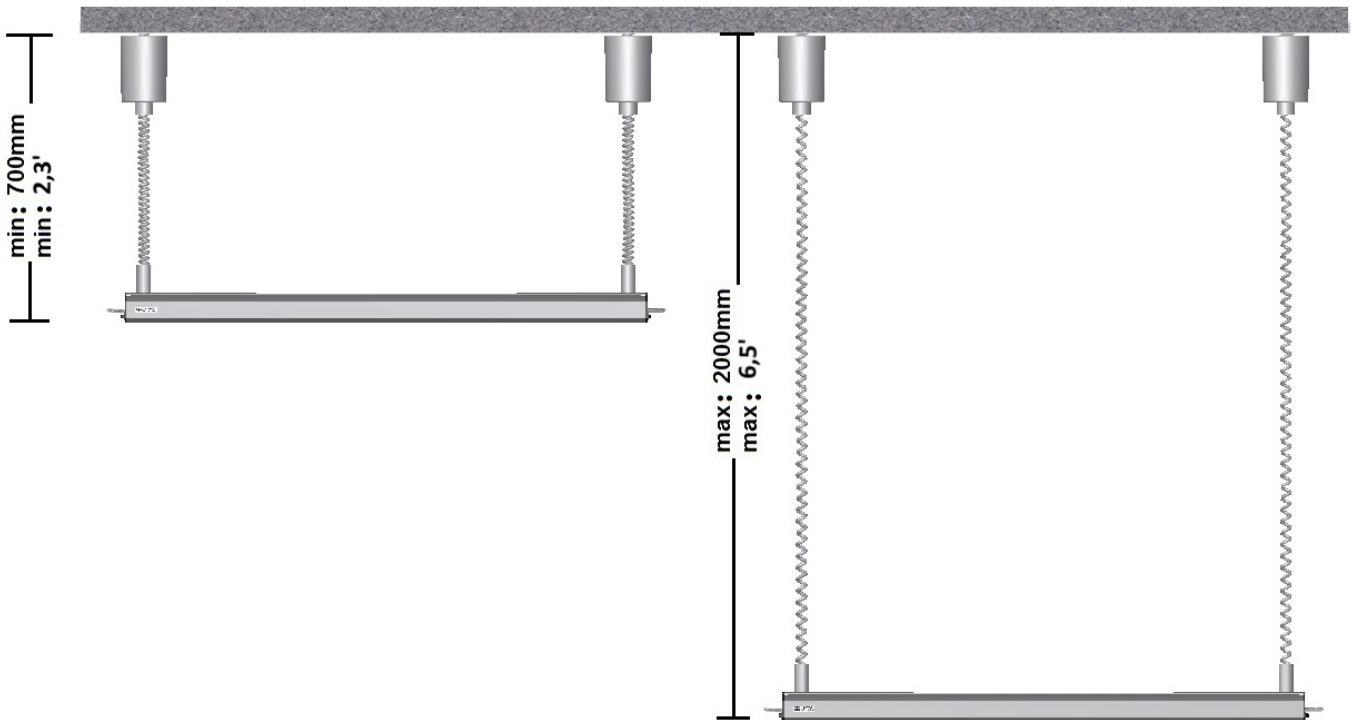

Suspension / Height of Room

The ceiling should be designed for a minimum load of 25kg/m or 20lbs./ft). If you have a suspended gypsum board ceiling, slats have to be put inside for the hang-up hooks. Consultancy is recommended.

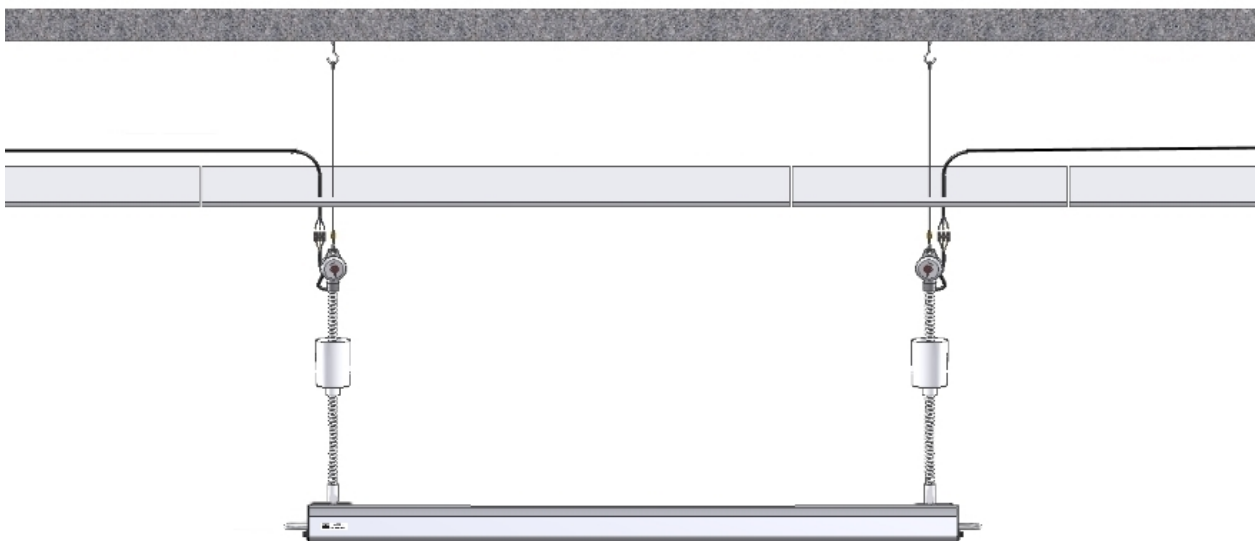

DIALITE X LED

Rise & Fall Pendant

2 x 24 Watt



Made in Germany

Information

Dimensions

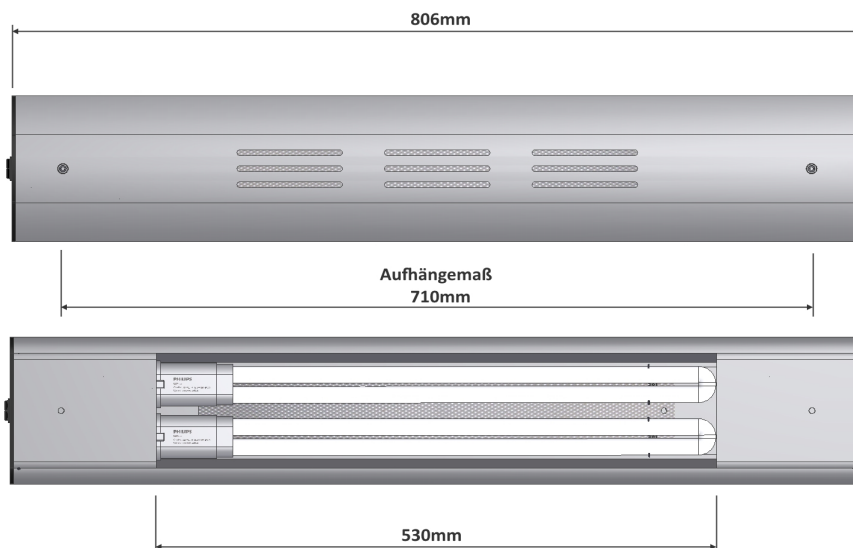

Weight About 3,4 kg (8.2 lbs.) including pendants.

Power 220-240V/50Hz. Degree/class of protection: IP20/I (grounded).
100-120V/50-60Hz by corresponding type or by optional voltage converter